

## Schottky Barrier Diode

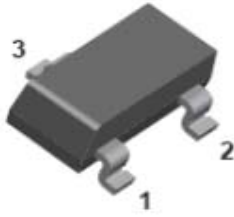

### Features

- Epoxy meets UL-94 V-0 flammability rating, halogen-free
- Moisture Sensitivity Level 1
- Low Forward Voltage
- Surface Mount device

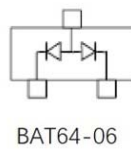
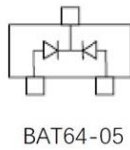
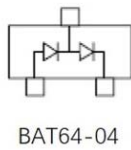
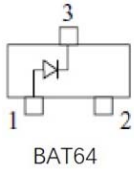

### Marking

BAT64	63S
BAT64-04	64S
BAT64-05	65S
BAT64-06	66S

### ■Maximum Rating. ( $T_A=25^{\circ}\text{C}$ Unless otherwise specified)

Item	Symbol	Unit	Value
Continuous Reverse Voltage	$V_R$	V	40
Forward Continuous Current, Per Leg	$I_F$	mA	250
Non-Repetitive Peak Forward Surge Current @ $t < 1\text{s}$	$I_{FSM}$	A	0.6
Total Power Dissipation @ $T_A=25^{\circ}\text{C}$	$P_D$	mW	200
Thermal Resistance, Junction to Ambient	$R_{\theta JA}$	$^{\circ}\text{C}/\text{W}$	500
Junction Temperature	$T_J$	$^{\circ}\text{C}$	-55 to +125
Storage temperature range	$T_{stg}$	$^{\circ}\text{C}$	-55 to +125

### ■Ordering Information (Example)

PREFERRED P/N	PACKING CODE	UNIT WEIGHT(g)	MINIMUM PACKAGE(pcs)	INNER BOX QUANTITY(pcs)	OUTER CARTON QUANTITY(pcs)	DELIVERY MODE
BAT64	F2	Approximate 0.008	3000	30000	120000	7" reel
BAT64-04	F2	Approximate 0.008	3000	30000	120000	7" reel
BAT64-05	F2	Approximate 0.008	3000	30000	120000	7" reel
BAT64-06	F2	Approximate 0.008	3000	30000	120000	7" reel



# BAT64 THRU BAT64-06

## ■ Electrical Characteristics (Ta=25°C Unless otherwise specified)

Item	Symbol	Unit	Conditions	Value
Minimum Breakdown Voltage	$V_R$	V	$I_R=0.1\text{mA}$	40
Maximum Instantaneous Forward Voltage	$V_F$	mV	$I_F=1\text{mA}$	350
			$I_F=10\text{mA}$	430
			$I_F=30\text{mA}$	520
			$I_F=100\text{mA}$	750
Maximum DC Reverse Current	$I_R$	$\mu\text{A}$	$V_R=25\text{V}$	2
Typical Junction Capacitance	$C_j$	pF	$f=1.0\text{MHz}$ , $V_R=1.0\text{V}$	10

## ■ Typical Characteristics

VF-IF

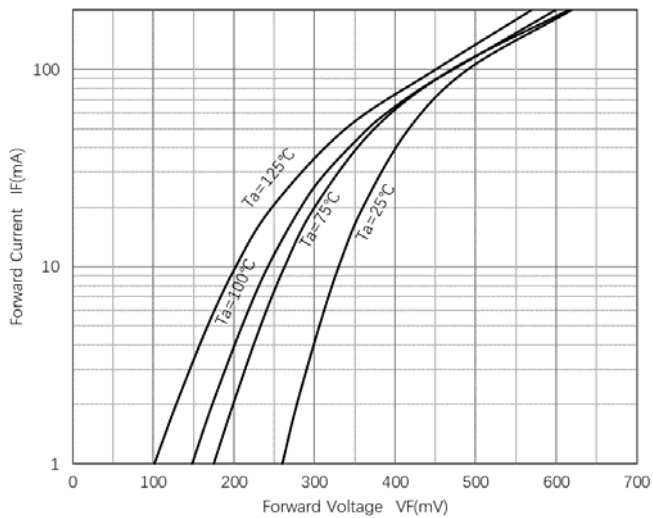

IR-VR

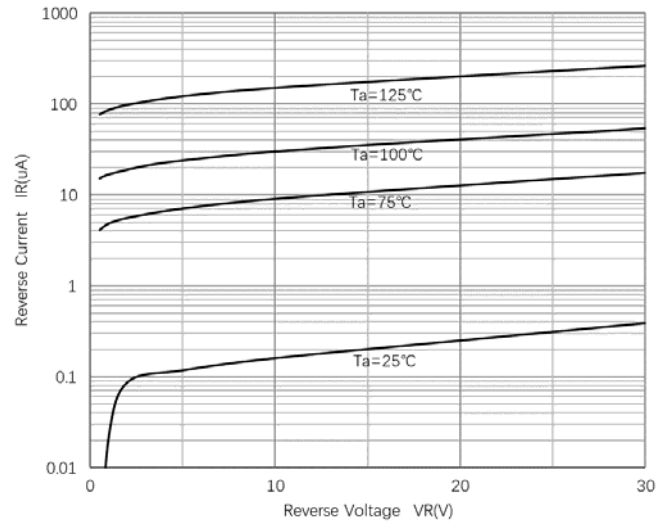

Cj-VR

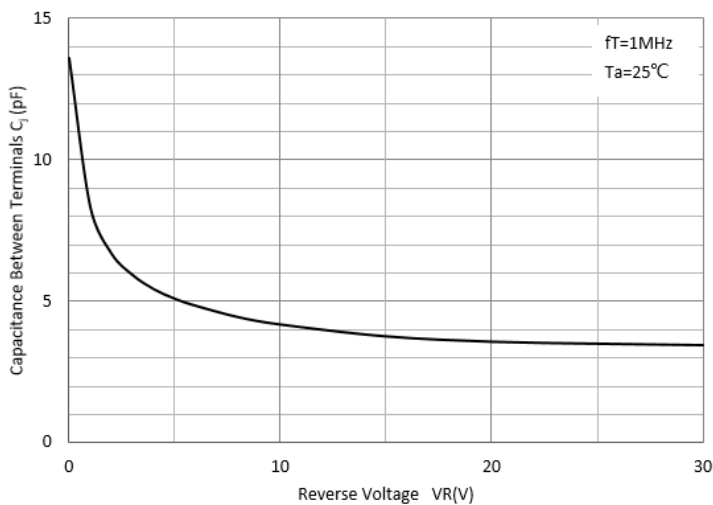

Power Derating Curve

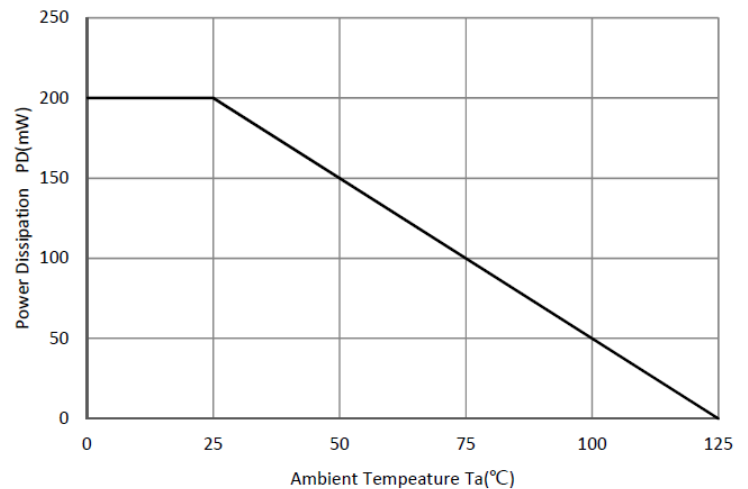



# BAT64 THRU BAT64-06

## ■SOT-23 Package Outline Dimensions

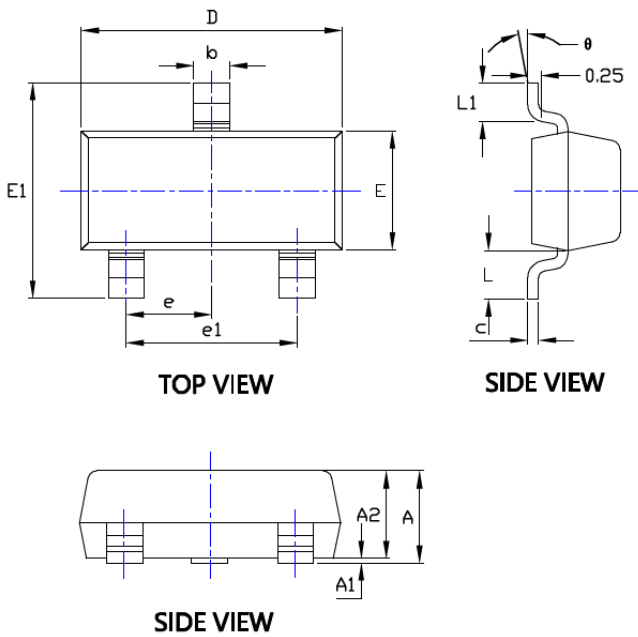

SYMBOL	DIMENSIONS			
	INCHES		Millimeter	
	MIN.	MAX.	MIN.	MAX.
A	0.035	0.045	0.900	1.150
A1	0.000	0.004	0.000	0.100
A2	0.035	0.041	0.900	1.050
b	0.012	0.020	0.300	0.500
c	0.004	0.008	0.100	0.200
D	0.110	0.118	2.800	3.000
E	0.047	0.055	1.200	1.400
E1	0.089	0.100	2.250	2.550
e	0.037TYP		0.950TYP	
e1	0.071	0.079	1.800	2.000
L	0.022REF		0.550REF	
L1	0.012	0.020	0.300	0.500
$\theta$	0°	8°	0°	8°

## ■SOT-23 Soldering Footprint

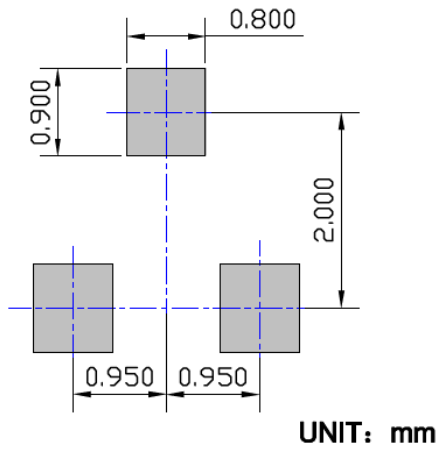



## BAT64 THRU BAT64-06

---

### Disclaimer

The information presented in this document is for reference only. Yangzhou Yangjie Electronic Technology Co., Ltd. reserves the right to make changes without notice for the specification of the products displayed herein to improve reliability, function or design or otherwise.

The product listed herein is designed to be used with ordinary electronic equipment or devices, and not designed to be used with equipment or devices which require high level of reliability and the malfunction of which would directly endanger human life (such as medical instruments, transportation equipment, aerospace machinery, nuclear-reactor controllers, fuel controllers and other safety devices), Yangjie or anyone on its behalf, assumes no responsibility or liability for any damages resulting from such improper use of sale.

This publication supersedes & replaces all information previously supplied. For additional information, please visit our website [http:// www.21yangjie.com](http://www.21yangjie.com) , or consult your nearest Yangjie's sales office for further assistance.